



All FUEL Chimney Liner Installation & Maintenance Instructions

Intended for use as a chimney liner in masonry and factory built chimneys for oil, gas or wood fired residential heating appliances with maximum running temperature of 1200° F (650° C) and occasional 1700° F (930° C) temperatures. UL tested up to 2100°F (1150°C).

Kits Contain:

Example: Wood Burning Stove

Part ID: **2SFKITX**_ _ _ _

- Z-Flex S/S Flexible Liner
- Rain Cap
- Top Support
- Chimney Flashing
- Lock N Go Tee

Example: Fireplace Insert

Part ID: **2INSERTKT**_ _ _ _

- Z-Flex S/S Flexible Liner
- Z-Max Rain Cap
- Z-Max Chimney Flashing
- Insert Connector

Manufacturer's address:

Flexmaster Canada Ltd.
452 Attwell Drive
Etobicoke, ON M9W
5C3

CANADA ONLY



ULC-S635

FOR SAFETY'S SAKE

Chimney relining and chimney repairs must be done with the utmost of care. Please ensure before starting that the safety aspect of the installation has been looked after. Secure your ladders and scaffolding, wear protective gear and the appropriate footwear and gloves before starting. Avoid problems through proper safety measures ensuring every installation is an accident free installation.

MODEL "SF"

GENERAL INSTRUCTIONS

Installer's Name:

Installer's Address:

Installation Date:

- BBWPESBQEBDDNMBUPOPGDSEPTPUFIEPOPUIFTTOHMFEXBMMMOFSBCPWFBIDINOFZ**
 - #** **IFTFPGSBODBQBOEGMBTIOHBSFSFRSFEUPQSEWFOUNPTUSEGSPNEOUFSOHUIFMIOFSBOEUIFTQB**
UIFMIOFSBOEDINOFZ
 - ETUFESBODBQTOODPSQPSBUOHCSETDSEFOTBSFOEDFTTBSZBOEPSSFRSFEOTPNFBSEBTCUNBZCF**
UPCMPDLBHFIUISPFIIGSFFOHINPTUSFOBSEBTPGMPXBNCFOUUFENQFSBUSFOTMUBUIPSUZIBWOH
KSTEDUPO
 - EOFSNTUOPUCFGFMEIPWBMEE**
 - &** **IFUBGFRQFSBUPOPGBMOOHTZTUENITCBTFEPOUIFTFPGQBSUTTIQQMEECZUIFNBOGBDUSESBOEUI**
QFSGPSNBODFNBZCFBGGFDFUEGUIFDPNCOBUPOPGUIFTFQBSUTTIPOPUTFEQBDUBMCMEOHIDPO
 - IFMOOHTZTUENITBGFEUZDPEFDPNQMBODZXBSSBOUZBOEQFSGPSNBODFNBZCFDPNQSPNITFEGUI**
OTUSDUBOTBSFOPUGPMPXFE
 - ISPSUPO TUBMMBUPOPGUIFMOOHTZTUENOU PBNBTPOSZDINOFZUIFDINOFZNTUCFUIPSPHIMZD**
DIEDLFEGPSDSBDLEMPPTFBSNTTOHCSDLTNPSUBSPUIFSNBUSBMTUIBUDPMEIOICUDPSSFDU
UIFMOOHTZTUENBOEUIBUUIFBSTQBDEDMFBSDODFTCFUXFFOUIFNBTPOSZDINOFZFYUFSPSBOE
NBUSBMTCFDIEDLFEUPWESGZUIBUUIFDINOFZITOBDDPSEBODFXUIBQQMDBCMFCMEOHIDPEFS
 - GUIFHYTUOHTZTUENITGPOEOPUUPCFODPNQMBODFXUIBQQMDBCMFCMEOHIDPEFBOERSUIFTFO**
OTUSDUBOTUIFMOFSTIBMMOPUCFOTUBMMFEUUMBQQSPQSBUEFTUEQTIBWECFFOUBLEFOOPSEFS
PSWFOUOUPDPNQMBODFXUIUIFBQQMDBCMFDPEFBOEPSUIFTFOTUSDUBOT
 - OTUBMMBUPOPGUIFMOOHTZTUENOU PBOEYTUOHDINOFZPSWFOUEPFTOPUOBOZXBZQHSBEFU**
SEMOFETZTUENBOENBLEFUTUBCMFGPSBOZBQQMDBUPOTUIBUSERSEBWFOUPSINOFZPGBIHIES
IBOEMOHDBQBCMUIZBOBMUFOSBUWEGEMPSBOZPUIFSNPSFTFWFSFTFSWDFUIBOUIFPSHOBMDIN
XIDIUITOTUBMMFE
 - IFBUIPSUZIBWOHKSTEDUPOITDIBT(BTOTQFEDUPOUIPSUZLQDQBM#MEOHEQBSUNFOUSE**
EQBSUNFOUSEFISWFOUPO#SFBFUDTIPMECFDPOTMUFECCFGPSEOTUBMMBUPOUPEFUFSNOFUIFO
PCUBOBQFSNU
- 3/7**
- BMSFUPO TQEDUBOEDMFBOMOOHTZTUENBTUUMOFFEONBOUFOBODFOTUSDUBOTNBZSETMUOG**
PUIFSTBGFEUZIBBSETTFUIFTFBOEBQQMBODFNBOGBDUSESHTOTUSDUPOTESOHUIFHYBNOBUPOB
MOOHTZTUEN

GENERAL INSTRUCTIONS

WARNING: Do not use any materials other than those specified in this instruction.

1. Read the installation instructions carefully prior to installing the chimney liner. If doubts exist, contact your local distributor or **Flexmaster Canada Ltd.** at 416-679-0045.
2. Clean and repair chimney as required. **NOTE:** Removal of all tar glazed creosote is a must prior to installation of chimney liner. Also, cracked, loose or missing bricks, mortar or other materials that could inhibit correct installation of the chimney lining system, should be removed/repaired.
3. Contact your local building or fire officials about any restrictions and inspections required.
4. The wall penetration assemblies must not be located directly behind a heating appliance.
5. The chimney liner **must not** be sized less than that specified in the appliance manufacturer's instructions.
6. The liner may be purchased in various lengths to suit chimney height up to a maximum length of 65 ft (19.8 m).
 - **Note:** It is recommended to have the liner in one continuous length, however if liner must be joined to achieve correct length use Part ID 2CNNTRC_ _.
7. Nose cone & insulation kits are catalog items sold separately.
8. Be sure to extend the chimney liner to conform to applicable building codes (local & national). That is, chimneys are required to extend at least **three (3) feet above the highest point where they**

pass through the roof of a building, and at least two (2) feet higher than any portion of the building within 10 feet (see illustration on page 3).

9. The air space clearance between the masonry chimney exterior and combustible materials should be checked to verify that the chimney is in accordance with the clearance specifications contained in the CAN/CSA-B365 Standard or other recognized major building codes, i.e., on an exterior chimney, clearance is 1" while on an interior chimney, clearance is 2".

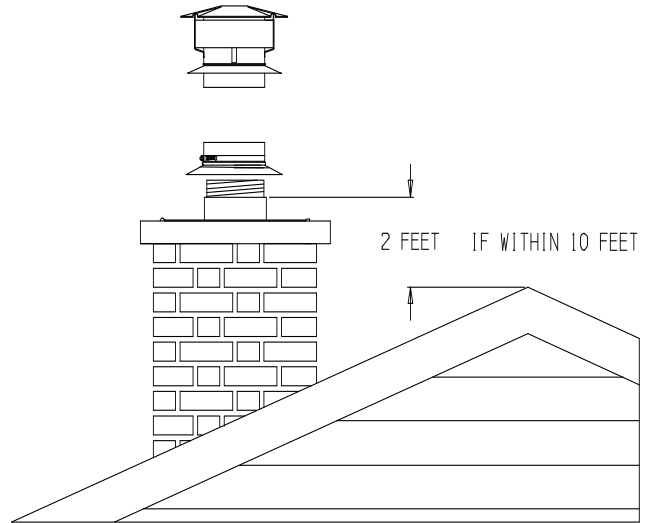

10. The "SF" Liner is intended for installation into masonry and factory built chimneys that are used for the natural draft venting of gas-liquid, and solid-fuel-fired residential-type appliances in which the maximum continuous flue-gas outlet temperatures do not exceed 1200° F (650° C). The following list details only some intended uses of "SF" chimney liner. If your appliance is not on this list and you are not sure if it is appropriate to use with "SF" liner, contact the appliance manufacturer prior to installation.

- | | | |
|------------|--------------------|----------------|
| Furnace | Boiler | Water Heater |
| Burner | Fireplaces/Inserts | Ranges |
| Wood Stove | Pellet Stoves | Clothes Dryers |

11. The liner must be installed throughout the chimney to a maximum length of 65ft (19.8 m).

12. Chimney Requirements.

Liner Diameter (ID)	Internal Chimney Dimensions
4 inch	4 -5/8in x 4 -5/8in
5 inch	5 -5/8in x 5 -5/8in
6 inch	6 -5/8in x 6 -5/8in
7 inch	7 -5/8in x 7 -5/8in
8 inch	8 -5/8in x 8 -5/8in

Maximum Chimney Height = 65 Feet High Minimum Chimney Height = 10 Feet High
 Minimum Brick Thickness = 3 1/2 Inches Thick.

13. Ensure access to clean out tee is in accordance with the enforcing authorities and clearances are maintained to your local building codes.

INSTALLATION PROCEDURE

1. Unroll the Flexible Liner to the maximum allowable length.
2. Next, install Lock N Go Tee body with cap onto liner. Insert liner into top of tee and snug up on clamp around liner. The branch will be installed later.

3. Now the Flexible Liner is ready to be installed in the chimney. Take a rope slightly longer than the liner and make a knot at one end of the rope and place other end through the backside of the Nose Cone and pull the rope until the knot is completely in the Nose Cone. Place the Nose Cone at the end of liner or bottom of ‡ Lock N Go Tee body with cap. To secure, use duct tape or other fastener.

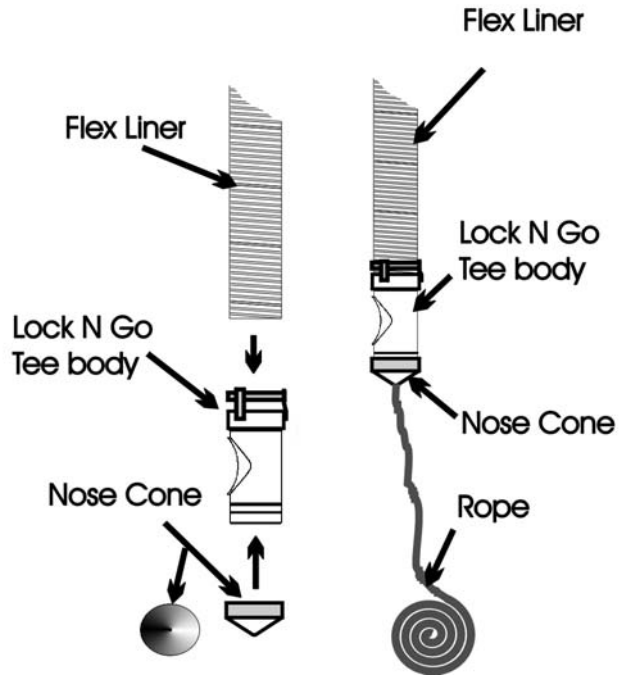

‡ **NOTE:** LOCK N GO TEE NOT REQUIRED WHEN INSTALLING WITH FIREPLACE INSERTS. USE THE "INSERT CONNECTOR". (See Fireplace Insert Installation below & Typical Installation # 3)

4. Guide the liner down the chimney, Nose Cone first, using the attached rope to the inlet opening. Remove Nose Cone through available opening.
5. Fully open the gear clamp on the Tee branch of the Lock N Go Tee and insert into the chimney inlet.

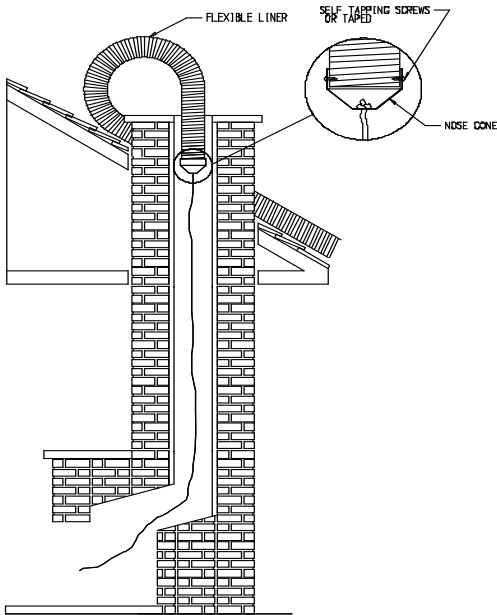

6. Continue to lower the Lock N Go Tee body down through the opened gear clamp of Tee branch. Align through branch and secure branch to the body by tightening the gear clamp from inside the branch until snug. Using a standard mortar mix, cement around the horizontal portion of the Lock N Go Tee at the inlet opening.

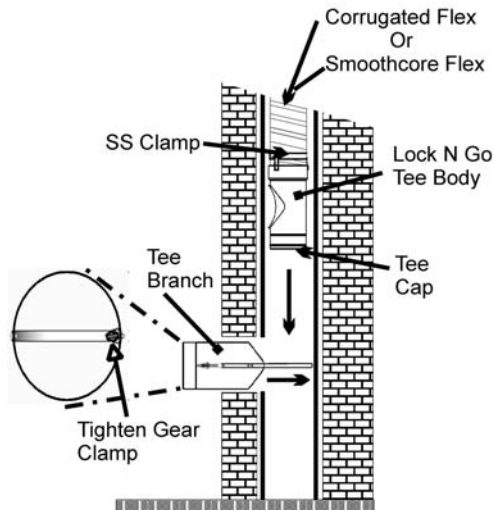

Z-LOK FLEX TEE ADDENDUM

- The Z-Lok Flex Tee design allows for simple quick installation.
- Secure the tee body to the liner by tightening the gear clamp.
- Once the liner with tee body is lowered and in place align the tee branch through the chimney breaching such that the tee branch Z-slots engages the tee body lugs.
- Firmly hold the tee branch and twist clockwise engaging the lock.
- Finish securing the tee branch to the chimney breaching.

Illustration

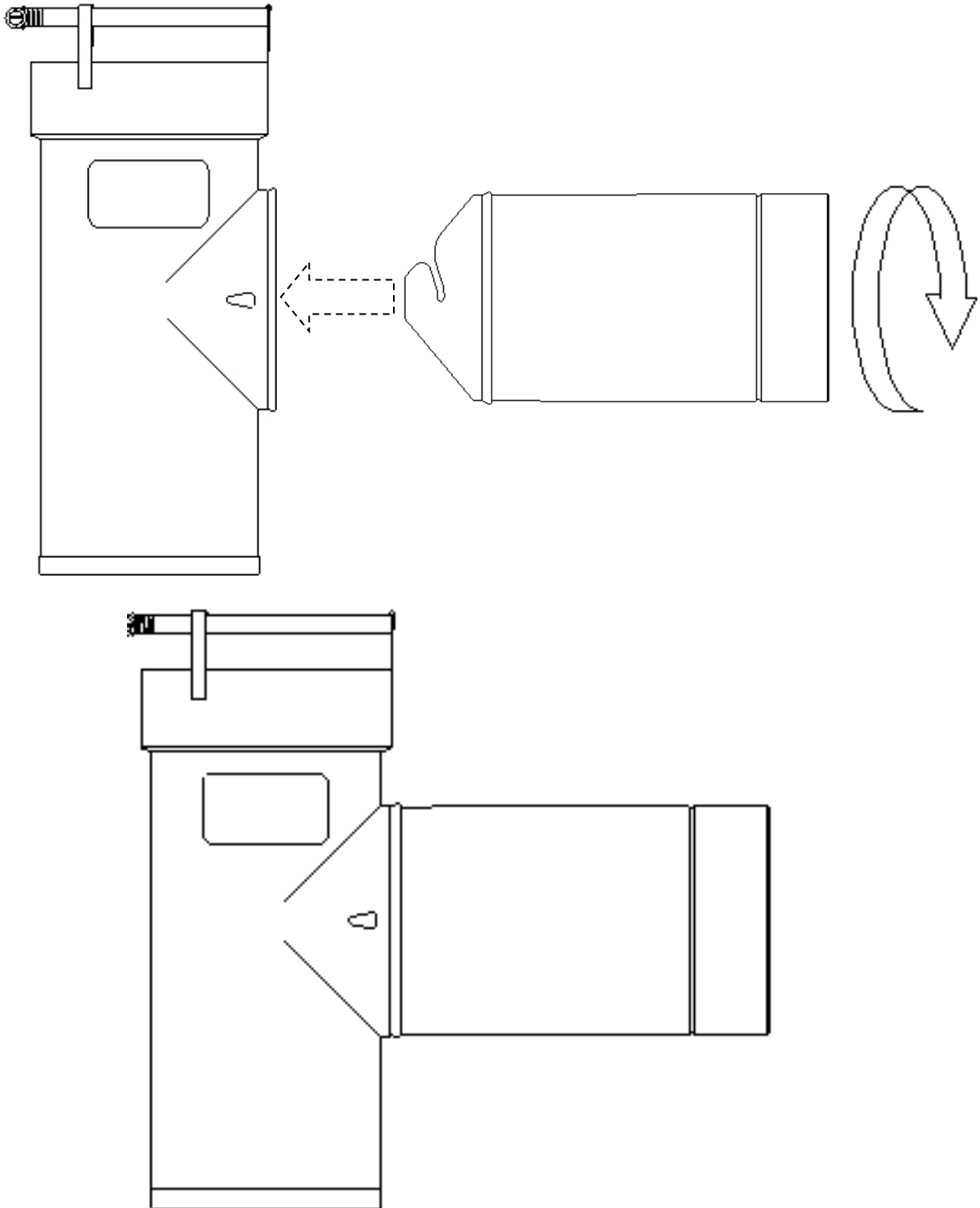

Z-MAX ADDENDUM

- The Z-Max Rain Cap and Z-Max Flashing, in combination eliminate the need for a Top Support when used in the Z-Flex Chimney Liner System.
- The Z-Max Flashing with integrated gear clamp affixes directly to the chimney liner by tightening the gear clamp.
- Trim the liner to size above the Z-Max Flashing.
- Align the Z-Max Rain Cap over top of the gear clamp of the Z-Max Flashing and tighten down on the gear clamp resulting in a double lock fail-safe cap. (see illustrations below)

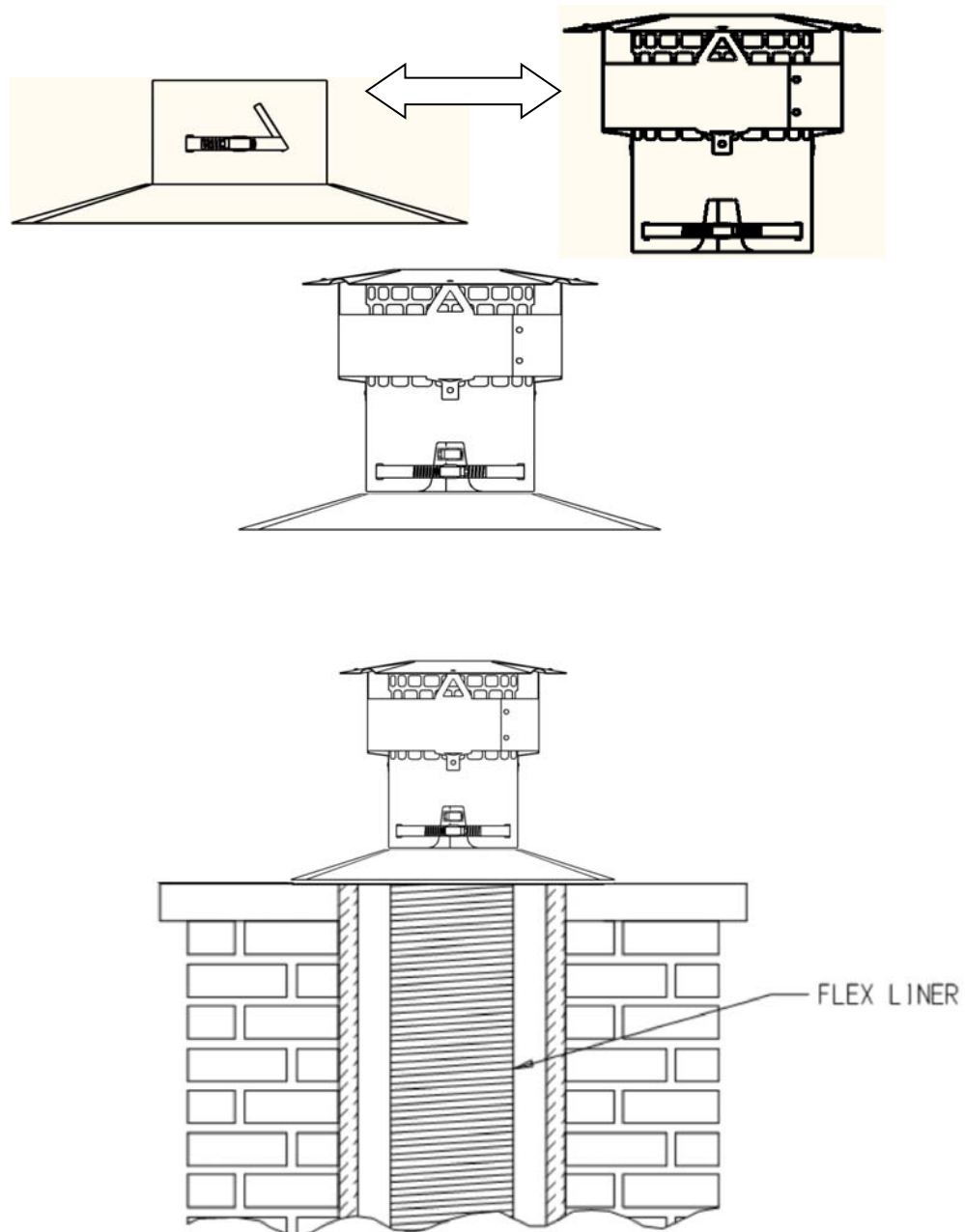

7. Allow at least 6"-12" of liner to extend above the top of the chimney, for attaching the Top Support, or Rain Cap. Next, place the Chimney Flashing over the liner and secure it to chimney top using suitable anchors. Using a quality high temperature sealant, caulk all joints and paint as necessary.

8. Slide Top Support over liner down to the top of the flashing collar allowing about a 1" overlap on the collar. Trim the liner level to top of Support using a knife or hacksaw. Next, insert Rain Cap into the liner. Tighten up on gear clamp supplied on Top Support crimping liner onto the Rain Cap base allowing it to overlap the flashing collar preventing any rain from getting between flashing collar and liner.

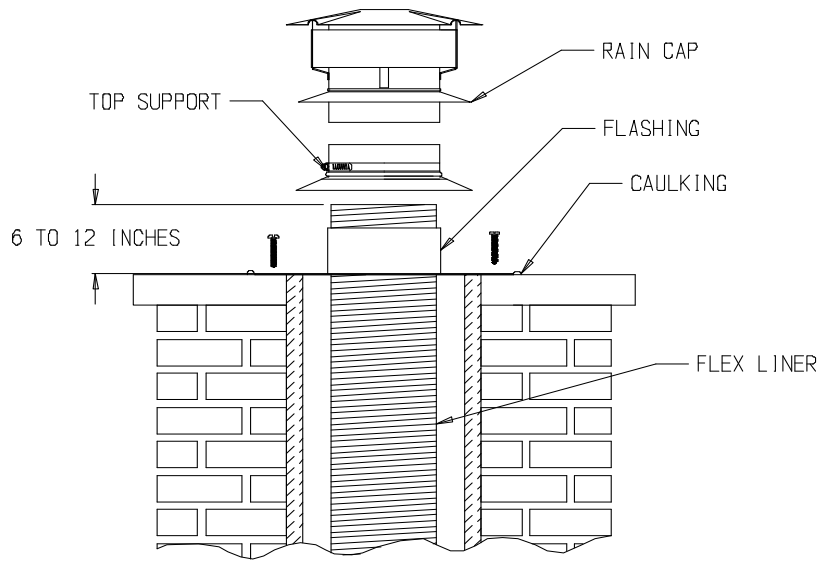

TYPICAL INSTALLATIONS

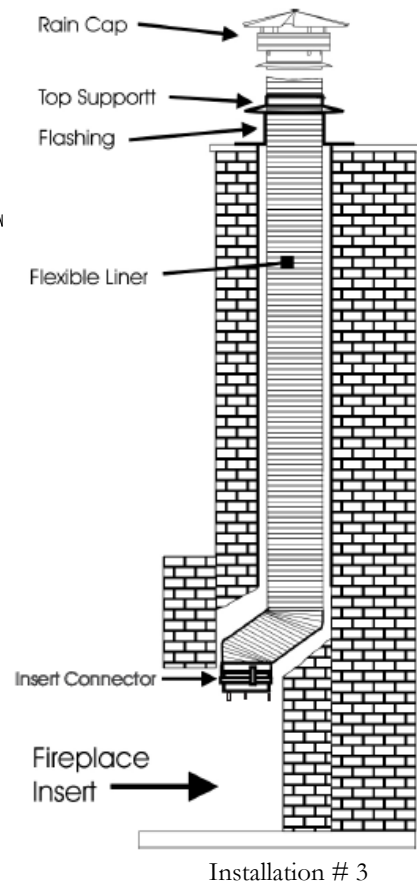
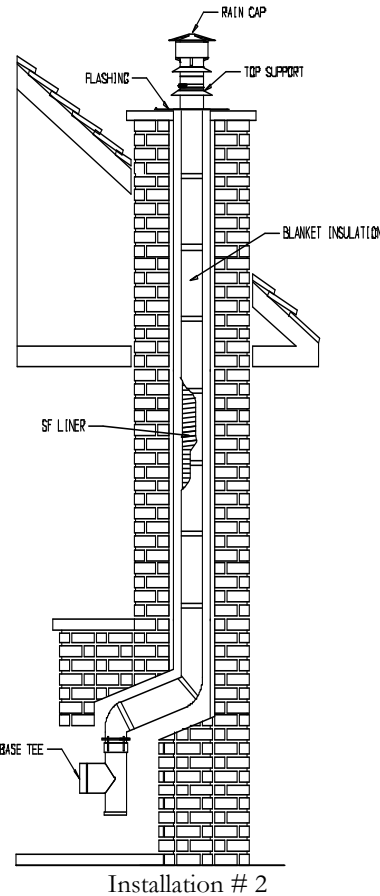
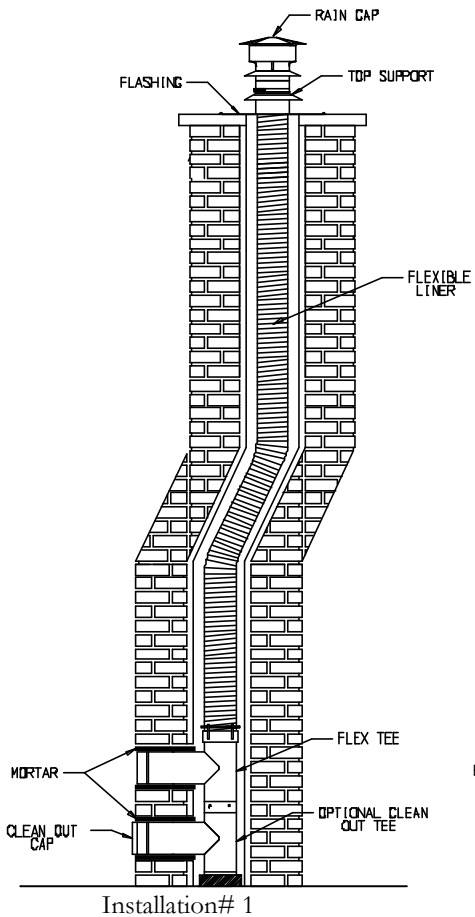

Note: Insulation Blanket is optional

FIREPLACE INSERT INSTALLATION

- 1) Prepare the chimney flue opening using best practice following all codes & standards having jurisdiction.
- 2) Connect the Insert Connector using stainless steel screws (not included) to the liner instead of the Lock N Go Tee in step 3 above.
- 3) Attach a rope to the crossbar in the Insert Connector and with the fireplace insert in position guide the free end of the rope down the chimney into the fireplace opening and into the insert outlet of the fireplace insert.
- 4) From inside the fireplace insert pull the rope through until the Insert Connector is in position in the outlet opening.
- 5) Secure the Insert Connector in the fireplace insert using appropriate fastener to the flue outlet collar and by bending back the tabs to the underside of fireplace insert

Note to installer: If there is no collar present on the outlet of the fireplace insert for the Insert Connector to fasten onto, bend the tabs of the Insert Connector back to the underside of fireplace insert fire chamber and affix using best practice method and/or approved cement.

- 6) The liner can now be secured into place by pulling the liner slack up through chimney.
- 7) Continue on from Step 7 above to finish off.

IMPORTANT: Follow Fireplace Insert instructions for flue connection when applicable.

PARTS COMMON TO Z-FLEX LINER SYSTEMS

Base Tee/ Lock N Go Tee / Flex Ready “A” Connector / Insert Connector
Chimney Flashing / Z-Max Flashing
Deluxe Rain Cap / Z-Max Rain Cap
Top Support

The replacement parts/components for Z-FLEX chimney liner system are available from Z-Flex.

MAINTENANCE INSTRUCTIONS

WARNING:

DO NOT USE ANY MATERIAL/PARTS OTHER THAN THOSE SPECIFIED IN THE INSTALLATION INSTRUCTIONS.

“Creosote and Soot Formation and Need for Removal”. When wood is burned slowly, it produces tar and other organic vapors, which combined with expelled moisture, forms creosote. The creosote vapors condense, in the relatively cool chimney flue of a slow-burning fire. As a result, creosote residue accumulates on the flue lining. When ignited this makes an extremely hot fire. The chimney should be inspected every two (2) months during the heating season to determine if a creosote or soot buildup has occurred. If creosote or soot has accumulated, it should be removed to reduce the risk of chimney fire.

The recommended method of cleaning your Z-Flex Liner is with a poly brush approximately 1/8” larger than the diameter of your liner. The liner should be brushed until all creosote and soot have been removed.

It is recommended to have the chimney lining system inspected by a qualified chimney inspector, such as a certified chimney sweep, at least once annually.

Any heating appliance connected to the chimney liner must not have a flue outlet size larger than the chimney liner area at its smallest point.



Z-FLEX®

Lifetime Liner Warranty

Z-Flex, Inc. warrants its stainless steel chimney liners to the original purchaser or if purchased by a contractor, to the end user. The warranty is valid for as long as the original purchaser owns the property in which the liner is installed, provided it is installed according to U.L. installation instructions. Deviating from the installation and use instructions included with the liner will void the warranty. Z-Flex warrants that at the time of shipping the stainless steel chimney liner will be free of manufacturer's defects in material and/or workmanship. Liability under the warranty shall be limited to the replacement of the liner and accessories found to be defective according to the terms of the warranty, and shall not include replacement installation or other costs.

IMPORTANT: Z-Flex Chimney Liners are designed to be used with these fuels only: natural gas, propane gas, oil, and seasoned hardwood. The following fuels are not recommended for use in Z-Flex chimney liners: coal, ocean driftwood or garbage. Excessive condensation with high chlorine content will corrode some stainless steel. Where these conditions prevail, we recommend AL29-4C™ Stainless Steel Liners. Refer to equipment manufacturer's installation instructions for proper liner material for appliances which produce condensation.

Excessive creosote accumulation, sulphur residue from burning coal or the use of unapproved chemical cleaners may cause chimney fires that could warp the liner or may corrode the liner. Such misuse will void the warranty.

To activate the warranty, the purchaser or end user must complete and return the Z-Flex warranty registration card within ninety (90) days of installation. Upon receipt of written notice of any defect, Z-Flex reserves the right to examine or engage others to examine the liner. Such examination must establish reasonable proof of defective material or workmanship justifying replacement.

The sole remedy for breach of any and all warranties and the sole remedies for Z-Flex's liability of any kind shall be limited to the remedies provided herein. Z-Flex shall not be liable for any special, incidental, indirect or consequential damages, or for any claim against the purchaser or end user by any other party. EXCEPT AS SPECIFICALLY PROVIDED HEREIN, Z-FLEX DOES NOT MAKE ANY EXPRESS OR IMPLIED WARRANTIES, INCLUDING BUT NOT LIMITED TO THE IMPLIED WARRANTIES OF MERCHANTABILITY AND FITNESS FOR A PARTICULAR USE. Some states do not allow the exclusion of implied warranties or the limitation or exclusion of liability for incidental or consequential damages, so the above limitations may not apply to you. You may also have other rights which vary from state to state.

For further information, call or write to:

**NOVAFLEX
20 East Pearce Street
Richmond Hill, ON
L4B 1B7
Tel: (905)-731-9411**

Z-FLEX® Warranty Registration Card

For this warranty to be effective this card must be completed upon purchase of the covered liner and returned to Z-FLEX, Inc.

NAME: _____

ADDRESS: _____

LINER PURCHASED FROM: _____

DATE OF INSTALLATION: _____

FIREPLACE INSERT, STOVE OR FURNACE MODEL: _____